

# JVC



ENGLISH

## VIDEO CASSETTE PLAYER

# HR-P51A

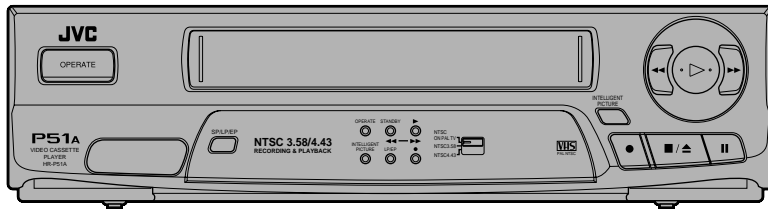
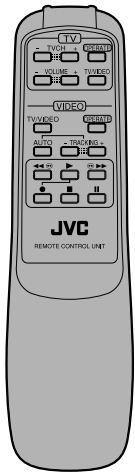

# INSTRUCTIONS

# Table of contents

Thank you for purchasing this JVC video cassette player. To ensure optimum performance of this unit, please read this instruction manual thoroughly.

Precautions .....	2
Controls and terminals .....	3
Wireless remote control .....	4
Connections .....	5
Setting the video channel .....	6
The video cassette .....	6
Playback .....	7
Playback features .....	8
Recording .....	9
Editing .....	9
Troubleshooting .....	10
Specifications .....	10

## Features

- 3 system (PAL/MESECAM/NTSC)
- NTSC playback (on PAL television)
- RF output G/K switchable
- Digital auto tracking
- HQ (High Quality)
- Intelligent picture
- Auto playback function
- Repeat playback
- Shuttle search
- Still and slow motion
- Line recording

## Automatic features

### Auto power on

The video cassette player is automatically turned on when the tape is inserted.

### Auto rewind

The video tape is automatically rewound when the end of the tape is reached during the play, recording or shuttle search forward mode.

### Auto playback

If the video cassette's safety tab has been removed, playback will begin automatically when the tape is inserted into the video cassette player.

### Power off eject

Even when the video cassette player's power is off, pressing the eject button will turn the power on and eject the tape. Once ejected, the power will be turned off again automatically.

### Auto head cleaning

When a tape is loaded or ejected the VCP video head is cleaned automatically.



- Only cassettes marked "VHS" can be used with this video cassette player.

# Precautions

The rating plate and the safety caution are on the rear of the unit.

**WARNING: DANGEROUS VOLTAGE INSIDE**

**WARNING: TO PREVENT FIRE OR SHOCK HAZARD, DO NOT EXPOSE THIS UNIT TO RAIN OR MOISTURE.**

The OPERATE button does not completely shut off mains power from the unit, but switches operating current on and off.

This unit is produced to comply with Standard IEC Publ. 65.

**Please follow these precautions. Not doing so may result in damage to the VCP, remote control, or video cassette.**

- Avoid extreme heat and direct sunlight.
- Avoid extreme cold.
- Avoid extreme humidity.
- Avoid dust.
- Avoid places subject to vibrations.
- Avoid strong magnetic fields.
- Do not block the VCP's ventilation openings.
- Do not place anything heavy on the VCP or remote control.
- Do not place anything which might spill on top of the VCP or remote control.
- Do not place the VCP on cushions, pillows, or thick carpeting.
- Use the VCP in a stable, horizontal position only.
- Place cassettes in cassette cases and store vertically.

### Beware of moisture condensation

Moisture in the air will condense on the VCP when you move it from a cold place to a warm place, or under extremely humid conditions — just as water droplets form on the surface of a glass filled with cold liquid. Moisture condensation on the head drum will cause damage to the tape. In conditions where condensation may occur, keep the VCP's power turned on for a few hours to let the moisture dry.

### When transporting

- Be sure to remove cassette from VCP before packing.
- Avoid violent shocks to the VCP during packing and transport.

# Controls and terminals

## Front panel

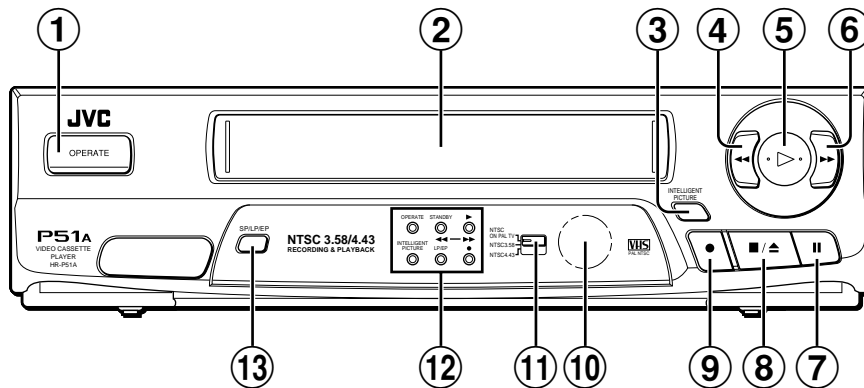

- ① **OPERATE button**  
To turn the power on and off (standby mode).
- ② **Cassette loading slot**  
Load the video cassette here.
- ③ **INTELLIGENT PICTURE button**  
To get the intelligent picture.
- ④ **Rewind ◀◀ button**  
To rewind the video tape and to start reverse shuttle search playback mode.
- ⑤ **Play ▷ button**  
To start playback.
- ⑥ **Fast forward ▶▶ button**  
To fast forward the video tape and to start forward shuttle search playback mode.
- ⑦ **Pause || button**  
To freeze the picture during playback. Also to engage the recording pause mode.
- ⑧ **Stop/Eject ■/▲ button**  
To stop playback and to eject the video tape.
- ⑨ **Record ● button**  
To start recording.
- ⑩ **Remote sensor window**  
For remote control operation.
- ⑪ **Colour System Output switch**  
Select to watch an NTSC tape.
- ⑫ **Mode indicators**
  - OPERATE indicator**
    - Lights when the power turns on.
    - Blinks while a cassette is ejected.
  - STANDBY / Rewind indicator**
    - Lights when the power turns off (Standby mode).
    - Blinks during rewind mode.
    - Blinks slowly during rewind power off mode.
  - Play / Fast forward indicator**
    - Lights during playback mode.
    - Blinks during fast forward mode.
    - Blinks slowly during repeat playback mode.
  - INTELLIGENT PICTURE indicator**
    - Lights when the intelligent picture is on.
  - LP/EP indicator**
    - Lights the tape speed is LP(PAL) or EP(NTSC) mode.
  - Record indicator**
    - Lights during recording mode.
    - Blinks during recording pause mode.
- ⑬ **SP/LP/EP button**  
To select the recording tape speed.

## Rear panel

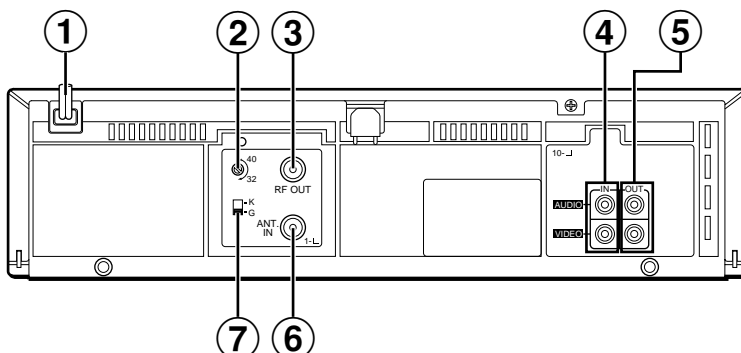

- ① **AC power cord**
- ② **RF channel adjustment screw**
- ③ **RF. OUT terminal**
- ④ **AUDIO/VIDEO IN terminals**
- ⑤ **AUDIO/VIDEO OUT terminals**
- ⑥ **ANT. IN terminal**
- ⑦ **TV system switch**

# Wireless remote control

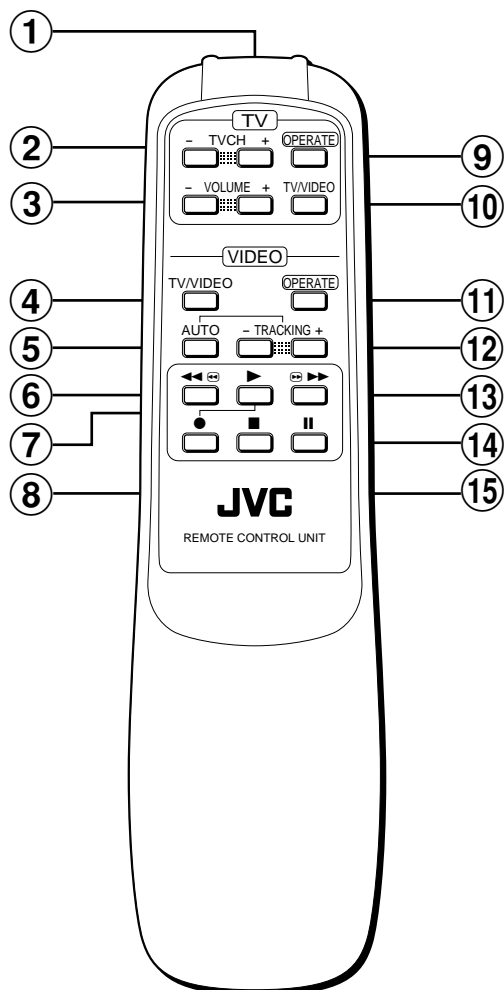
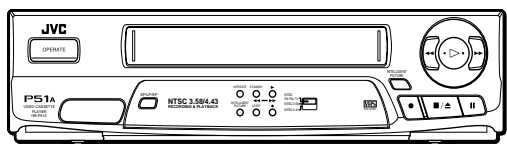

When using the remote control for operation of the video cassette player, make sure that it is pointed at the remote sensor window.

You can also use the player's remote control to operate a JVC television.

- ① **Transmitting window**
- ② **TV channel -/+ buttons**
- ③ **TV VOLUME -/+ buttons**
- ④ **TV/VIDEO (Player) button**  
Not function
- ⑤ **Digital AUTO TRACKING button**  
To cancel the Auto tracking mode.
- ⑥ **Rewind ◀◀ button**  
To rewind the video tape. Also to start reverse shuttle search playback.
- ⑦ **Play ▶ button**  
To start playback.
- ⑧ **Record ● button**  
Press the Record ● and Play ▶ buttons together, to start recording.
- ⑨ **OPERATE (TV) button**  
To turn the TV power on and off.
- ⑩ **TV/VIDEO (TV) button**  
To switch TV between TV and VIDEO (or AV).
- ⑪ **OPERATE (Player) button**  
To turn the power on and off (standby mode).
- ⑫ **TRACKING -/+ buttons**  
To adjust tracking during playback.
- ⑬ **Fast forward ▶▶ button**  
To fast forward the video tape. Also to start forward shuttle search playback.
- ⑭ **Pause || button**  
To freeze the picture during playback. Also to engage the recording pause mode.
- ⑮ **Stop □ button**  
To stop playback.

## Installing batteries

1 Slide the battery compartment cover upward and insert two AA, R6, UM-3 or equivalent size batteries, observing the correct + and - polarities (refer to the illustration).

2 Replace the battery compartment cover.

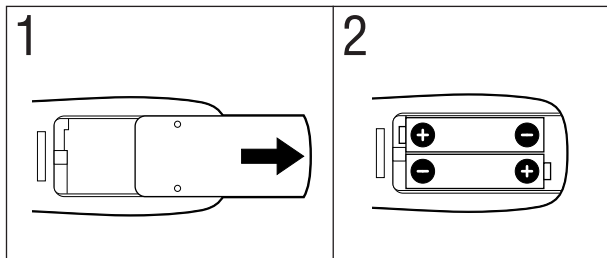

- The maximum operating distance of the remote control is about 8 m.

# Connections

Make sure that the power to the video cassette player and TV is off before making the following connections.

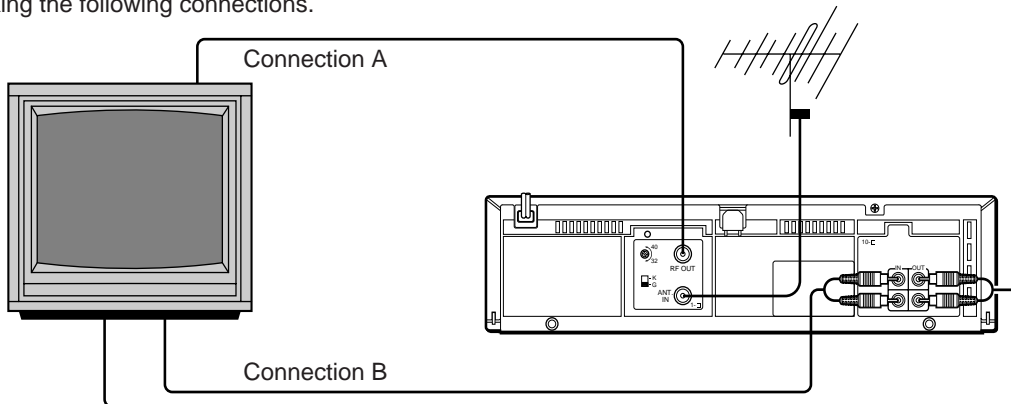

## Connection A (basic)

In order to use the video cassette player it must be connected between the antenna and the TV.

- 1 Connect your TV antenna cable to the video cassette player's ANT. IN terminal.
- 2 Connect one end of the provided RF antenna cable to the video cassette player's RF. OUT terminal and the other end to the TV's antenna terminal.
- 3 Connect the power cord to your household AC outlet.

### Note:

If you put a TV set directly on this VCP or install it too close to a TV set, noise may occur. If this noise occurs, separate the VCP and the TV set.

## Connection B

For connection of a TV that has VIDEO/AUDIO IN/OUT terminals. This connection is necessary to record TV programmes. Use RCA type pin connection cords (available from audio/video stores) for connection. This connection is in addition to connection A.

- 1 Follow steps 1 and 2 of "Connection A".
- 2 Connect the TV's VIDEO OUT and AUDIO OUT terminals to the video cassette player's VIDEO IN and AUDIO IN terminals.
- 3 Connect the TV's VIDEO IN and AUDIO IN terminals to the VCP's VIDEO OUT and AUDIO OUT terminals.
- 4 Connect the power cord to your household AC outlet.

## TV system

The TV system switch should be set as follows.

**K position:** Set to this position for K system areas (Eastern European countries).

**G position:** Set to this position for G system areas (Western European countries for example).

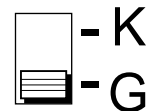

### Note:

- When connection B is used to connect the TV and video cassette player, setting the TV system switch is not necessary.

# Setting the video channel

To watch videos on your TV, it must be set to the same UHF channel as the video cassette player. This channel is used as the video channel.

This video cassette player has been preset to UHF channel 36.

## Note:

- When you have connected the VIDEO/AUDIO OUT terminals of this video cassette player to your TV's video/audio in terminals (connection B of the "Connections" section), setting the video channel is not necessary. In this case simply set the TV's TV/VCR switch to VCR.

**1 Turn the video cassette player's power on and load a pre-recorded video tape.**

**2 Turn on the TV and set it to UHF channel 36.**

### If UHF channel 36 is being used for broadcasting in your area:

Adjust the TV's channel selector a little at a time until the TV screen is blank (set it towards a higher or lower channel). Adjust the RF channel adjustment screw on the rear panel of the video cassette player a little at a time until the playback picture appears on the TV screen.

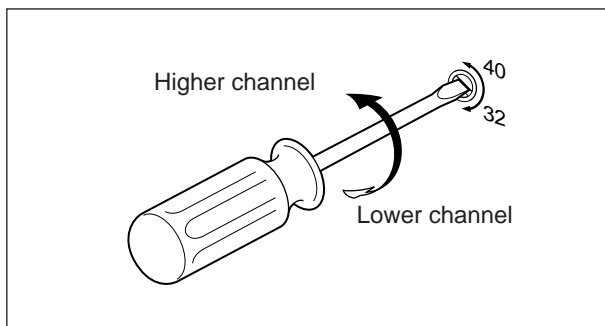

- If the TV's channel selector was set to a higher channel than channel 36, turn the RF channel adjustment screw to the right and vice versa.

**3 Adjust the TV picture with the TV's tuning controls.**

## Using the TV while the video cassette player is connected

To watch a normal TV broadcast, select a TV station with the TV's channel selector.

# The video cassette

## Inserting a cassette

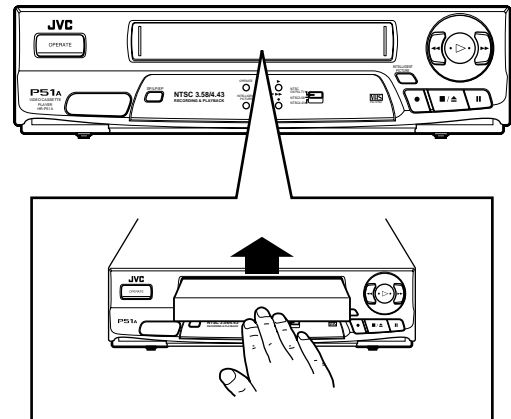

### ■ Insert the cassette as shown and push it gently into the video cassette player.

The video cassette player will be turned on automatically and the cassette will be loaded.

### ■ Press the Stop/Eject ■/▲ button to eject a cassette.

During playback or recording, press the ■/▲ button twice (once to stop the tape and once more to eject it).

## Notes:

- If the cassette's safety tab has been removed, playback will start automatically when the cassette is inserted.
- A cassette can also be ejected when the power is off.
- The OPERATE indicator blinks while the cassette is ejected.

## Special note on Video Cassettes

To prevent accidental recording on a recorded cassette, remove its safety tab. To record on it later, cover the hole with adhesive tape.

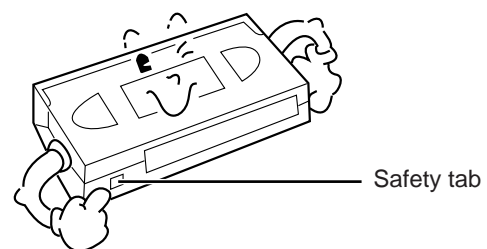

# Playback

NTSC, PAL and MESECAM video tapes can be played back on this video cassette player. Refer to the "Colour system output mode selection" section for details.

## Before proceeding:

- Turn on the power of the TV and video cassette player.
- Make sure that the TV is set to the video channel or that the TV's TV/VIDEO switch is set to VIDEO (refer to the "Setting the video channel" section for details).

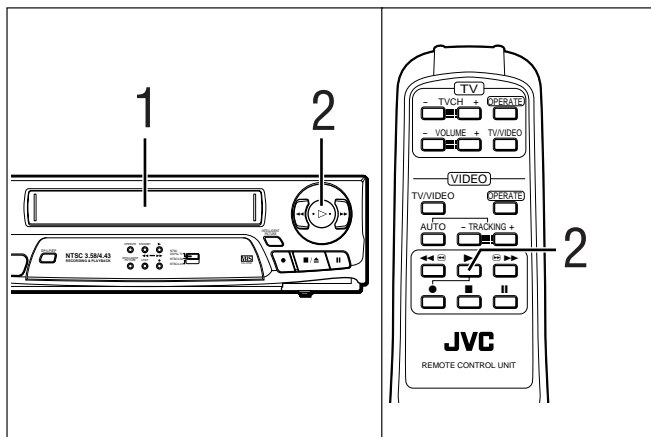

**1 Load a pre-recorded cassette.**  
If the safety tab on the cassette is removed, playback will start automatically.

**2 Press the Play ► button to start playback.**

■ Press the Stop/Eject ■/▲ button or the remote control's Stop □ button to stop playback.

To fast forward or rewind the tape:

■ From the stop mode, press the Fast forward ►► or Rewind ◀◀ button.

## NTSC Playback on PAL TV

- The vertical size of the playback picture will shrink and some picture "noise" may appear on the screen.
- The playback picture may roll. In this case adjust the picture with the TV's vertical hold knob (with some TV's this adjustment may not be possible).
- The colour of the playback picture may differ from the original.
- In the forward/reverse shuttle search or still modes there may be no colour depending on the TV and video cassette player combination.

## Colour system output mode selection

To watch an NTSC tape, it will be necessary to select one of the following output modes.

### Selecting the NTSC PLAYBACK ON PAL TV mode

Select this mode to watch NTSC tapes on a PAL system TV.

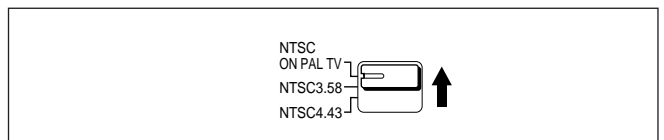

### Selecting the NTSC 3.58 mode

Select this mode to watch NTSC tapes on a NTSC system TV.

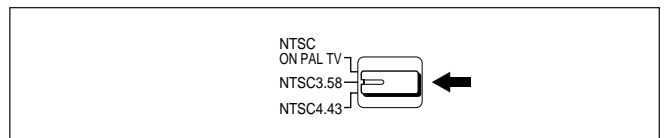

### Selecting the NTSC 4.43 mode

Select this mode to watch NTSC tapes on a multi-system TV (that has an NTSC 4.43 setting).

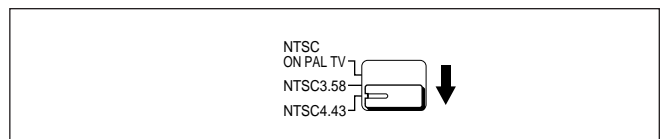

# Playback features

## Slow motion playback

Slow motion playback is 1/6 of the normal playback speed. The sound will be cut during slow motion playback.

**During playback:**

1 Press the **Pause** **||** button for 2 seconds.

■ Press the **Play** **▶** button to return to the normal playback speed.

**Notes:**

- If the picture shakes during the slow mode, use the manual tracking +/- buttons to correct the picture.
- There will be some picture disturbance and loss of colour during slow motion playback.

## Still picture and frame advance

Use this feature to freeze the playback picture and to advance one frame at a time. The sound will be cut during this mode.

**During playback:**

1 Press the **Pause** **||** button.  
The picture will be frozen.

2 Press the **Pause** **||** button repeatedly to advance frames.  
Each time the button is pressed the still picture will advance one frame.

■ Press the **Play** **▶** button to resume normal playback.

**Notes:**

- If the picture shakes during the still mode, use the manual tracking +/- buttons to correct the picture.
- After the picture has been frozen for approx. 5 minutes, the still mode will disengage to protect the video tape.

## Shuttle search playback

Use this feature during playback to visually locate any point on a recorded cassette. The sound will be cut during shuttle search operation.

**During playback:**

1 Press the **Fast forward** **▶▶** or **Rewind** **◀◀** button to engage shuttle search forward or reverse.

■ Press the **Play** **▶** button to resume normal playback.

**Notes:**

- When the video cassette player is in the stop mode, press the **Play** **▶** button to start playback before engaging the shuttle search mode.
- For short searches, keep **Fast forward** or **Rewind** button pressed for more than 2 second. When released, normal playback will continue.
- Disturbances in the shuttle search picture are normal and do not indicate a problem with the video cassette player.

## Intelligent picture

Use this feature to get a better picture when viewing tapes with noise such as rental tapes.

1 Press the **INTELLIGENT PICTURE** button.  
The **INTELLIGENT PICTURE** indicator will light.

■ Press the **INTELLIGENT PICTURE** button to cancel this feature.

## Repeat playback

Use this feature to repeat playback of a cassette 20 times.

**During playback:**

1 Press the **Play** **▶** button for more than 5 seconds.  
The **Play** indicator will blink slowly and playback of the cassette will repeat 20 times automatically.

2 Press the **Stop** **■** button to stop repeat playback.  
Tape playback will be stopped and the repeat playback mode will be cancelled.

## Rewind power off

When the tape has finished rewinding, the VCR will turn itself off.

**During stop:**

1 Press the **Rewind** **◀◀** button.

2 Press the **OPERATE** button within 2 seconds.  
The **STANDBY** indicator will blink.

## Tracking adjustment

Automatic tracking is adjusted each time a cassette is inserted in the video cassette player, you may wish to adjust tracking manually during playback.

**Manual tracking**

1 Press the remote control's **AUTO** button.

2 Press the remote control's **TRACKING +** or **-** button to adjust tracking.

■ Press the **AUTO** button to return to automatic tracking.

**Notes:**

- Tracking may need to be adjusted each time a different video tape is inserted for playback.
- Tracking will be automatically set to the reference position when the cassette is ejected.



# Recording

Use the following procedure to record TV programmes on a blank video tape.

## Before proceeding:

- To record TV programmes, the video cassette player must be connected to the TV as shown in connection B of the "Connections" section.
- Turn on the power of the TV and video cassette player.
- Make sure that the video cassette's safety tab is intact. If it has been removed, cover the hole with adhesive tape.

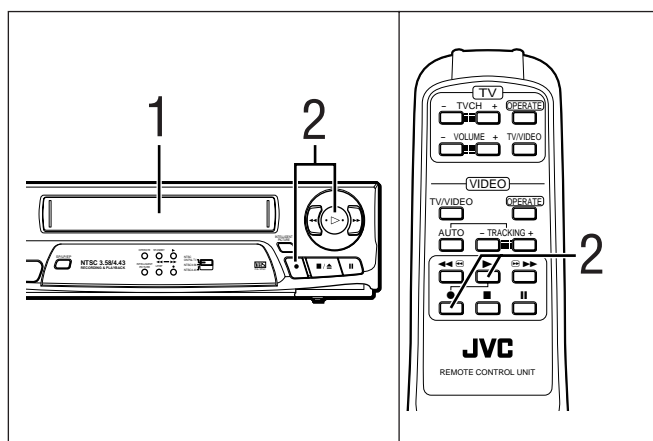

**1** Load a blank video tape.

**2** Press the Record ● button to start recording. (On the remote control unit press the Record ● and Play ► button at the same time.)

The recording indicator will light during recording.

■ Press the Stop/Eject ■/▲ button or the remote control's Stop □ button to stop recording.

### To stop recording temporarily:

■ Press the Pause II button.

The recording indicator will blink.

Press the Play ► button to resume recording.

### Notes:

- To engage recording standby, press the Record ● button and then press the Pause II button. The recording indicator will blink during recording standby. Press the Play ► button again to start recording.
- If the Record button does not work, check to see if the cassette safety tab has been removed.
- The player automatically stops when record-standby continues for more than 5 minutes.
- The video tape will be rewound automatically when the end of the tape is reached.

# Editing

## Editing To/From Another Recorder

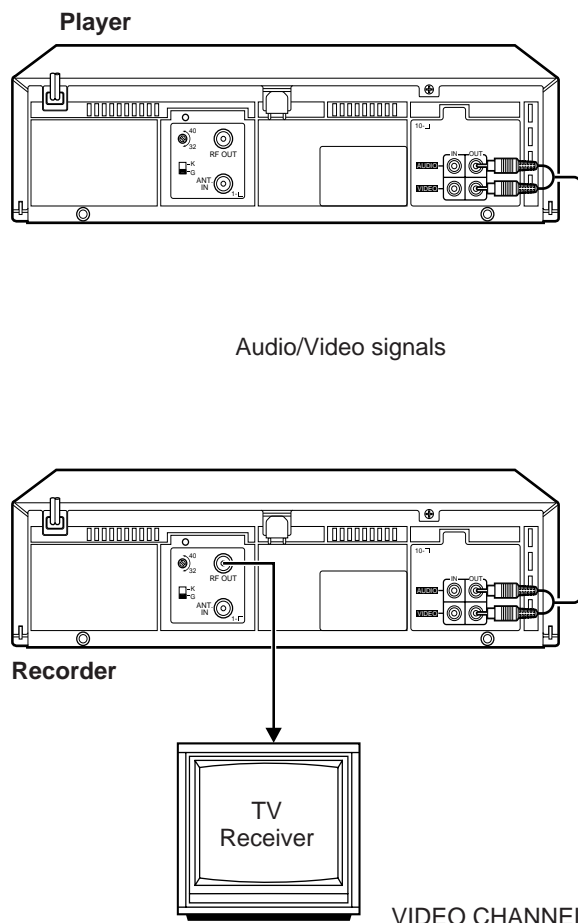

**1** Connect the player's AUDIO and VIDEO OUT connectors to the recorder's AUDIO and VIDEO IN connectors.

**2** Put the player in the Play mode.

**3** Put the recorder in the Record mode.

### Notes:

- NTSC tapes being played back in the NTSC PLAYBACK ON PAL TV mode cannot be dubbed to another recorder.
- When you dub an NTSC tape using your recorder as the playback deck, select NTSC 3.58 (or 4.43) with the Colour System Output switch.

### Important:

- To edit, both the player and the recorder must be of the same colour system. Press your recorder's Colour system switch to select the appropriate colour system.

# Troubleshooting

Problem	Check point
<b>No power</b>	Is the power cord plugged in? Is the power turned on?
<b>Tape cannot be ejected</b>	Was the video cassette player's <b>■/▲</b> button pressed?
<b>No picture</b>	Is the TV set to the video channel? Is a cassette loaded? Are the connections correct?
<b>No colour</b>	Set the Colour System Output switch according to the recorded tape system. When playing a MESECAM tape, select the NTSC 4.43 mode.
<b>Shuttle search does not function</b>	Is the video cassette player in the playback mode?
<b>Disturbances in playback picture</b>	Is tracking adjusted properly? Is the TV adjusted properly? Install this VCP a little way apart from the TV set.
<b>Remote control does not function</b>	The batteries are weak. Replace the batteries.
<b>Auto playback does not function</b>	The video cassette's recording safety tab has not been removed.
<b>Recording does not function</b>	Are the connections correct? Was the Record button pressed? The video cassette's recording safety tab is removed.
<b>The video cassette player does not function properly</b>	Microcomputer malfunction. Disconnect the power plug from the AC outlet and then re-insert it. The microcomputer will be reset to its initial mode.

## About Head cleaning

- If the picture playback becomes blurred, it does not mean that the recorded program has been erased.
- Dirt accumulated on the video heads after long periods of use causes such troubles. In this case, head cleaning requiring highly technical care is necessary.
- For head cleaning, consult the nearest JVC dealer.

# Specifications

Format .....	VHS Standard
Video recording system .....	Rotary, slant azimuth two-head helical scan system
Rotary heads .....	2 video heads
RF output .....	System G/K type modulation UHF ch 32 – 40 adjustable (preset ch 36)
Recording (line input) .....	PAL, SECAM (MESECAM tape) NTSC 3.58, NTSC 4.43
Playback (line output) .....	PAL, SECAM (MESECAM tape) NTSC 3.58 NTSC 4.43 Simulated PAL (NTSC tape)
<b>Video</b>	
Line input level .....	0.5 – 2.0 Vp-p/75 ohms, unbalanced
Line output level .....	1.0 Vp-p/75 ohms, unbalanced
S/N ratio .....	More than 46 dB
Horizontal resolution .....	More than 250 lines
<b>Audio</b>	
Line input level .....	–6 dBm/50 k ohms, unbalanced
Line output level .....	–6 dBm/1 k ohm, unbalanced
Frequency response .....	100 Hz to 10,000 Hz
<b>Recording/Playback time</b>	
CCIR .....	240 min. with E-240 cassette
NTSC .....	160 min. with T-160 cassette
<b>Tape speed</b>	
CCIR .....	23.39 mm/sec.
NTSC .....	33.35 mm/sec.
FF, REW time .....	Approx. 2 min. 30 sec. with E-180 cassette
<b>Power requirements</b>	
Rating .....	AC 110 – 240 V, 50/60 Hz
Operating .....	AC 90 – 260 V, 50/60 Hz
Power consumption .....	13 W
Operation temperature .....	5°C to 40°C
Dimensions .....	360 (W) × 94 (H) × 276 (D) mm
Weight .....	3.4 kg

## Standard accessories

Remote control unit .....	1
Batteries for remote control .....	2
RF antenna cable .....	1

- Design and specifications subject to change without notice.

# MEMO

---